

# 愛普科技股份有限公司

## 法人說明會

2018.09.13  
凱基證券12F

# 免責聲明

簡報中所提供對於產業及本公司前景之預測，係根據目前營運及公開資訊所做出之判斷，相關內容具風險與不確定性。任何外在環境的改變均可能影響公司實際營運與財務狀況，本簡報資料中所提供之資訊，不代表本公司對產業狀況或後續重大發展的完整論述，本公司亦不會因任何新的資訊或事件而更新相關資訊。



# 報告大綱

- 引言
- 營運焦點調整 & 未來展望
- 2018年上半年度財務重點

# 引言

- 營運策略調整
  - 專注高毛利客製化商品
    - 包含設計服務 & IP 授權
  - 調整低功耗產品營運模式
  - 提升標準型產品之毛利

# 營運焦點調整 & 未來展望

# 愛普的獲利模式

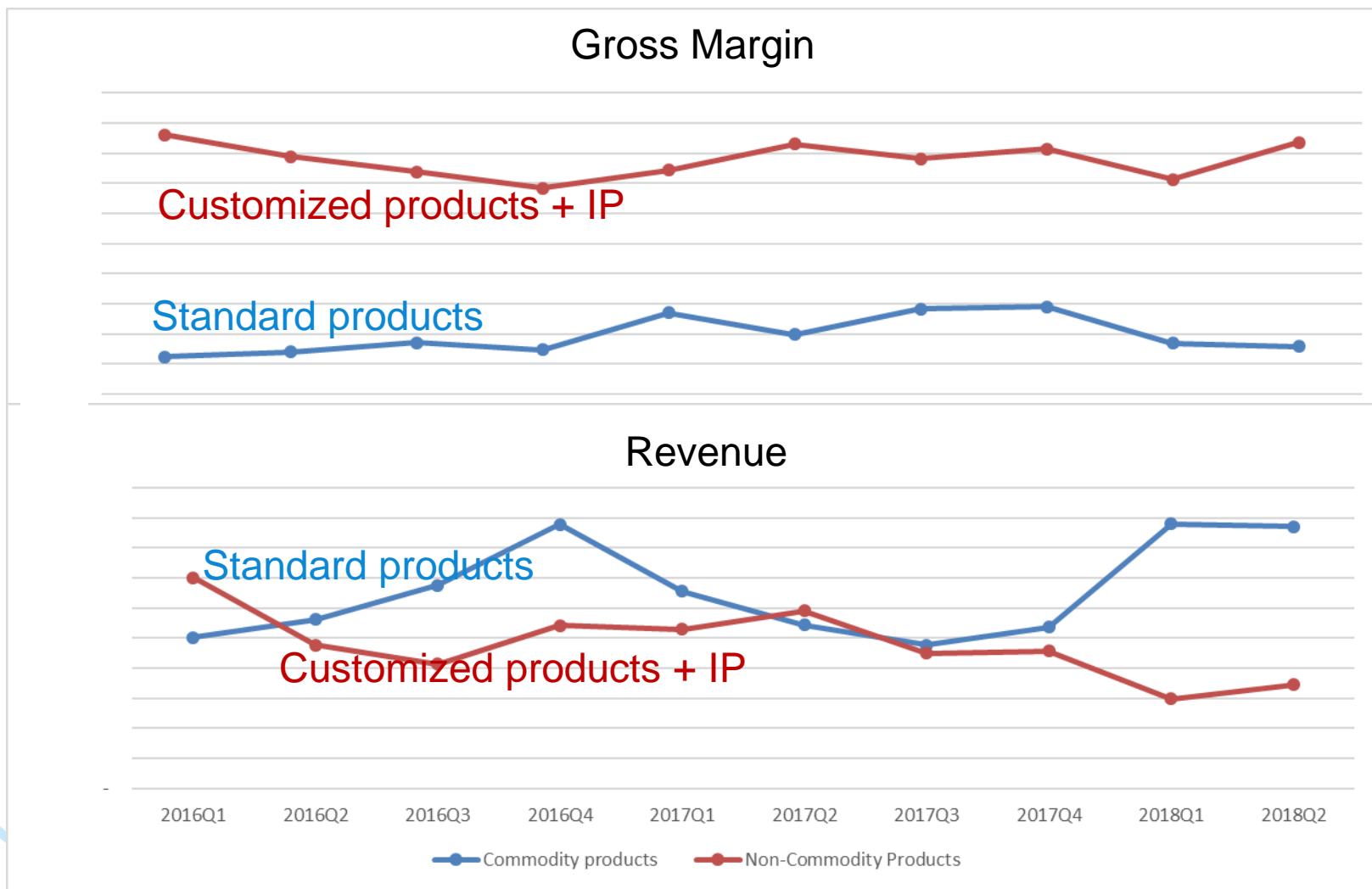

# 愛普獲利模式

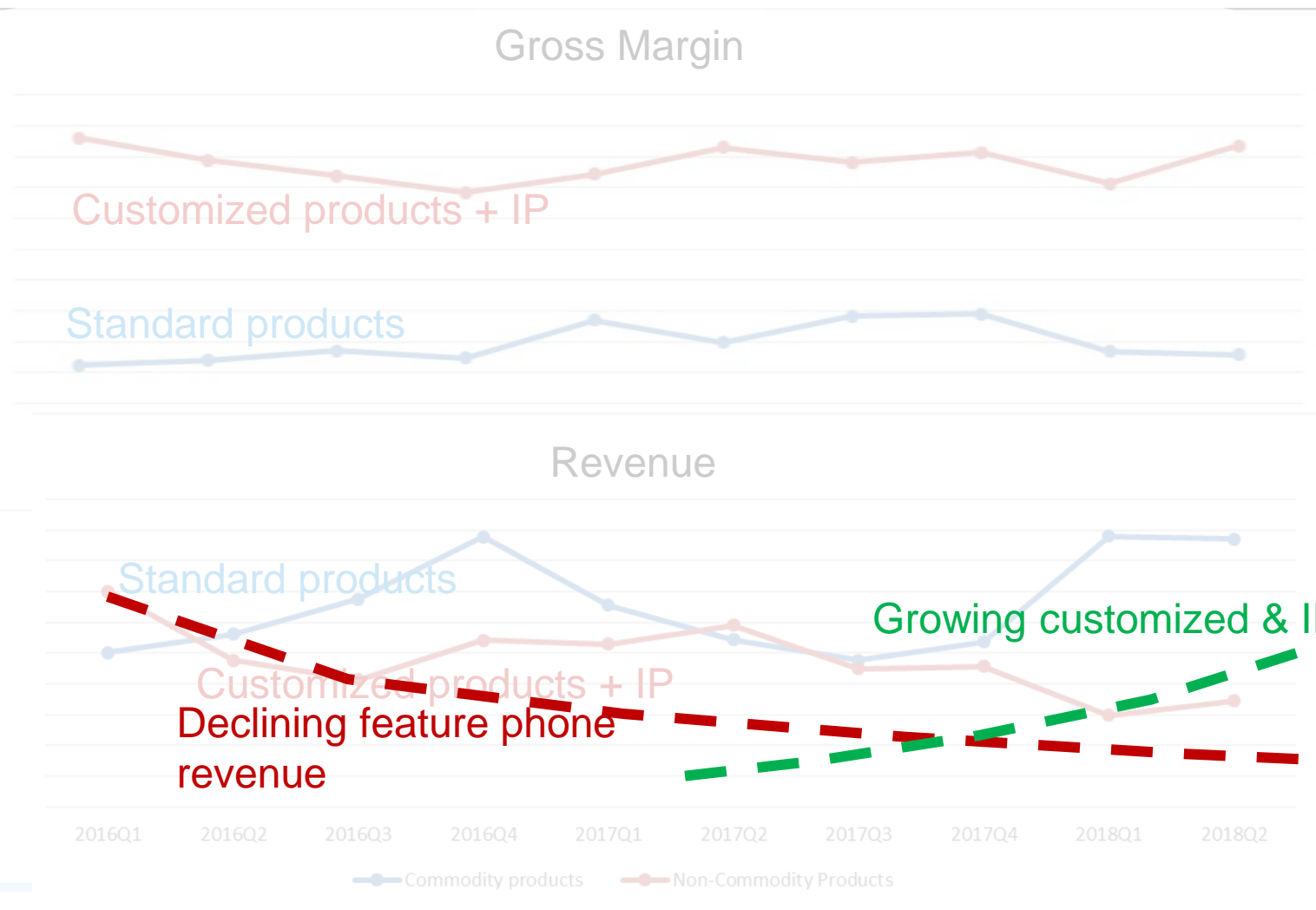

# 成長關鍵：客製化+智財權

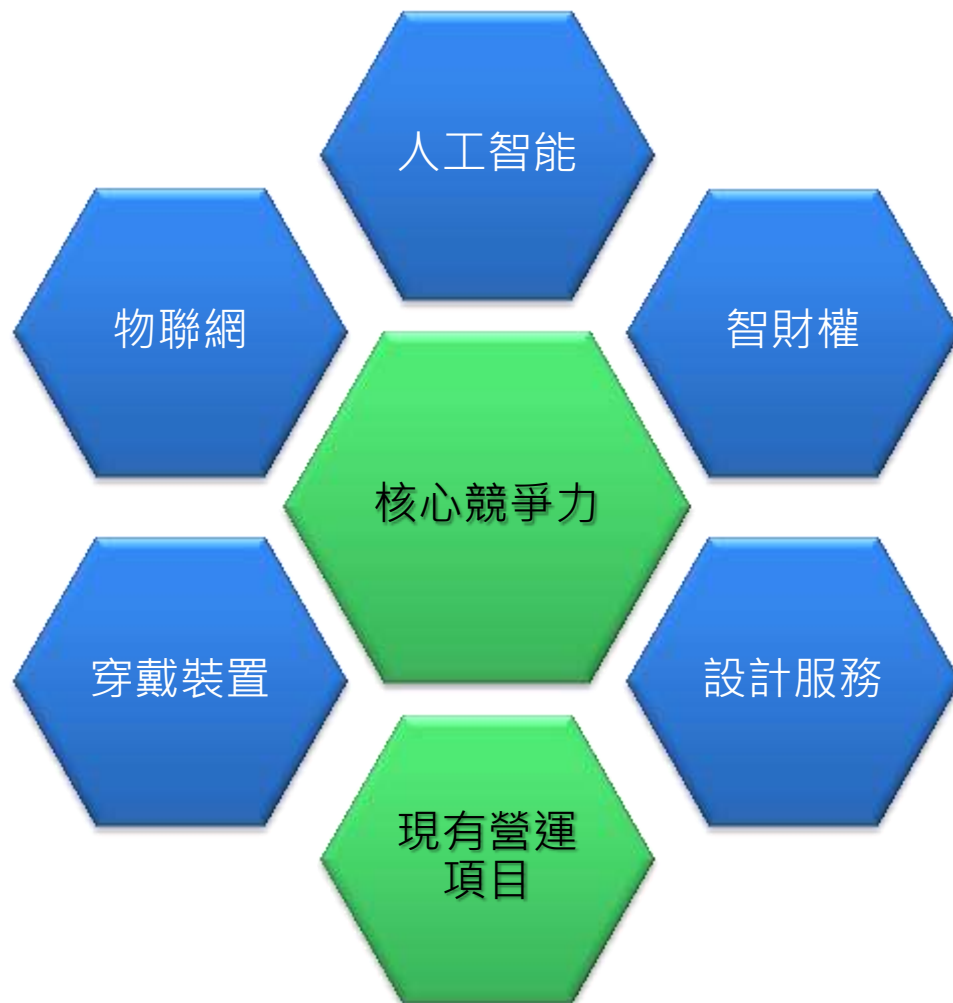



# 成長重點：核心競爭力

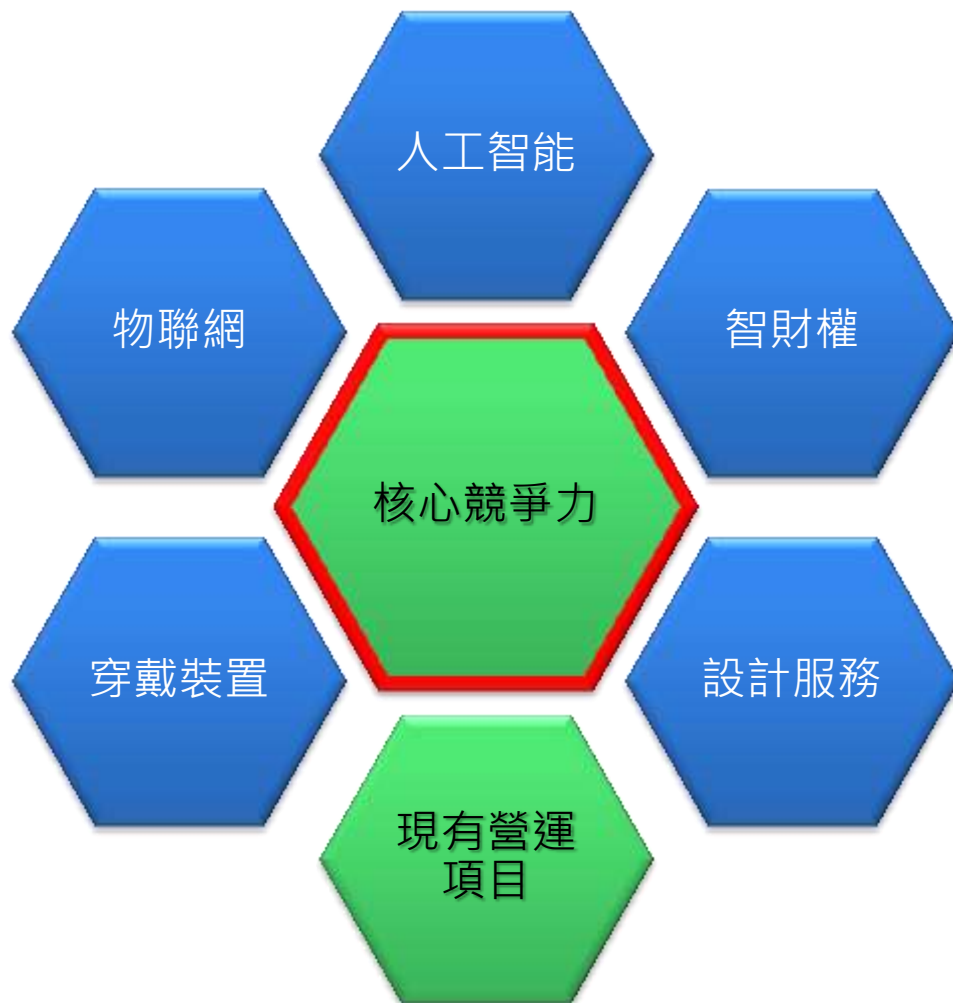

# 核心競爭力

- 超過 80+ 之研發團隊
  - 專精於系統及記憶體之開發設計
- 完整的產品佈局
  - PSRAM + LP + Standard, including DDR4, LP4
- 發展智財權(IP)授權服務

# 成長重點：現有營運項目



# 優化現有營運項目

- 調整低功耗記憶體產品之營運模式
  - 低毛利產品 銷售→授權
    - Profit neutral, higher margin, much lower risk
  - 部分產品之授權合約已簽訂，自Q4開始部分反映，2019.Q2全部反映

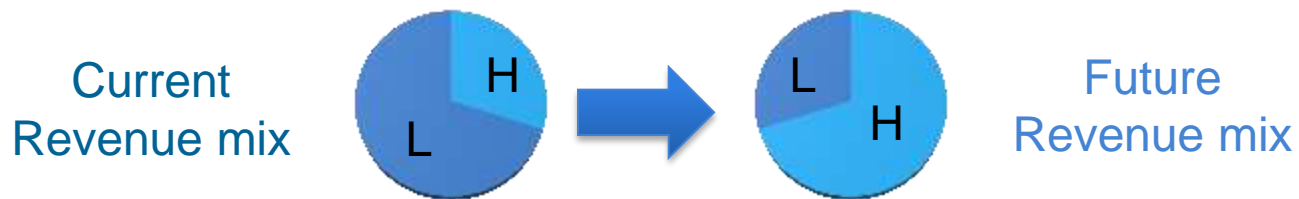

- 提升標準型產品毛利
  - Leverage design service → reduce R&D cost
  - Increase customized sales → improve margin
- Anti-cyclical on DRAM
  - 上升段：高成本、擠壓毛利
  - 下沈段：低成本、有毛利空間

# 成長動能：穿戴裝置

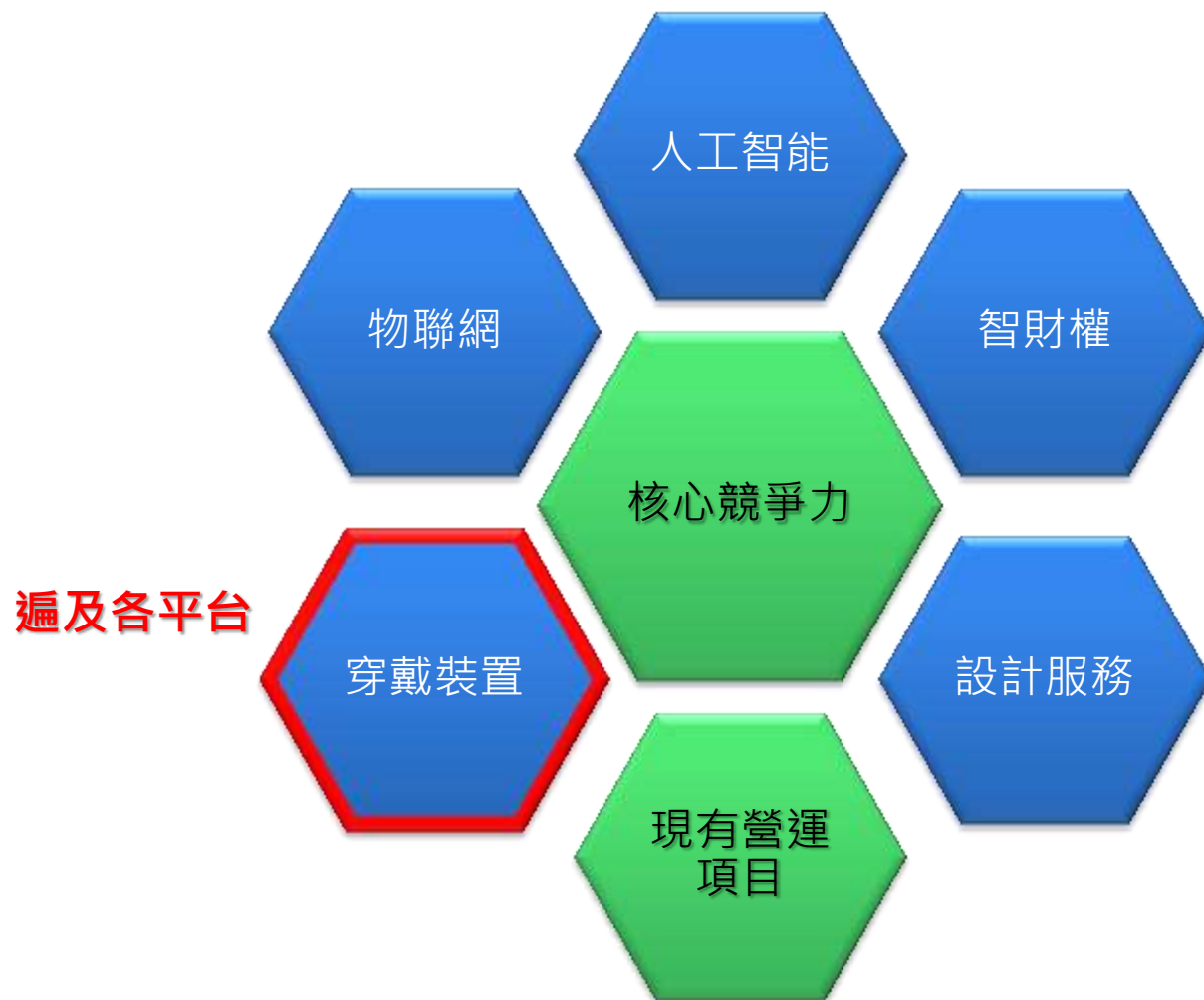

# 穿戴裝置

- 超低功耗、極簡化產品
- 遍及各平台
  - 智能手錶
  - 藍芽智能耳機：非蘋陣營主要品牌
- 從平台推展至客戶端

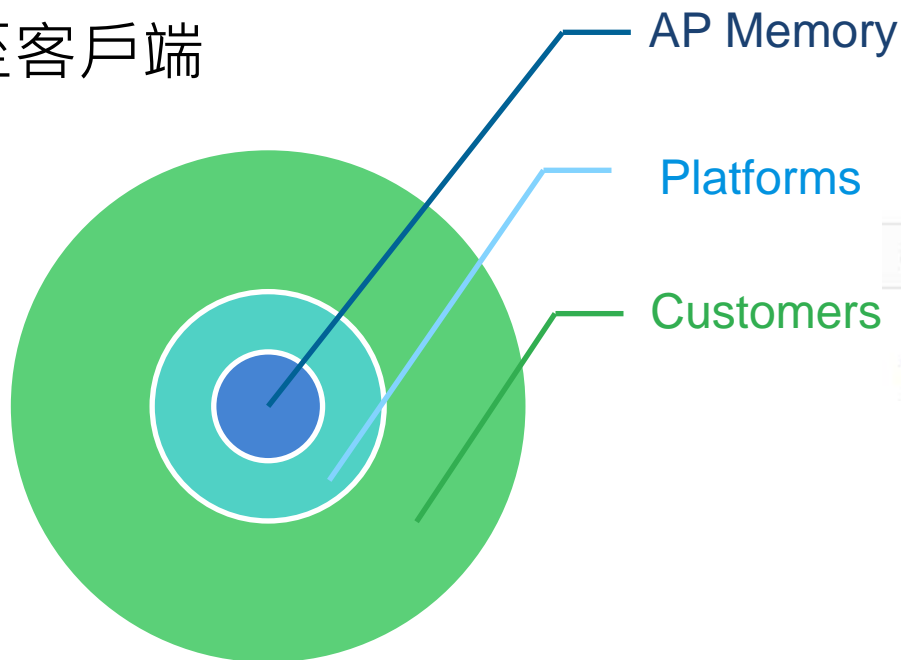

Home > ST Partner Program

**AP MEMORY**

# 成長動能：物聯網

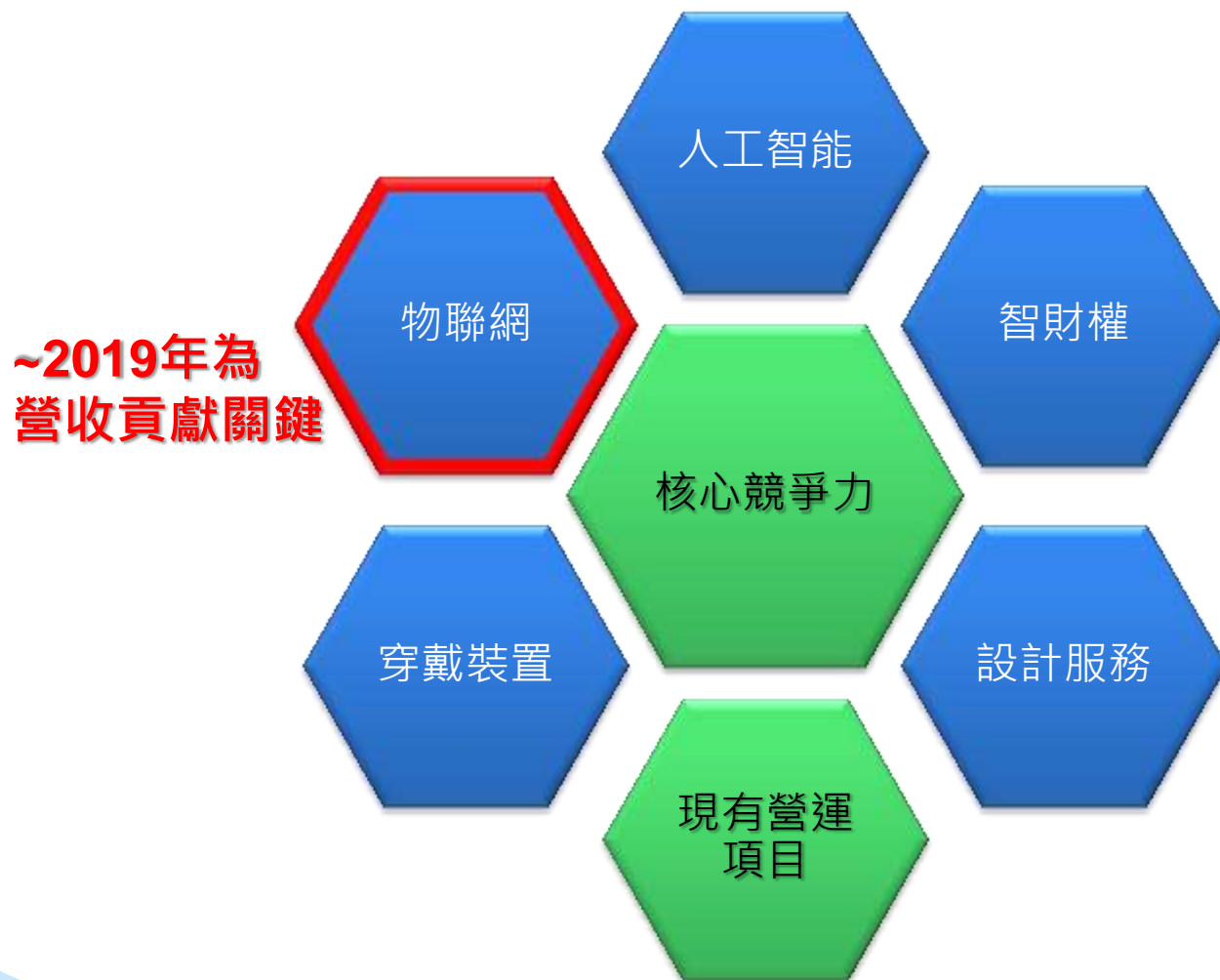

# 物聯網 / 智聯網

- 物聯網
  - Linux-based: 客製化LPDRAM
    - ~2019年為營收貢獻關鍵
  - RTOS-based: 超低功耗PSRAM
    - 逐步貢獻營收中
    - 由嵌入式SRAM轉化為PSRAM
- 智聯網 (人工智能 + 物聯網)
  - 新智聯網記憶體Design-in中
  - 預計自2019年起貢獻營收





# 成長動能：設計服務

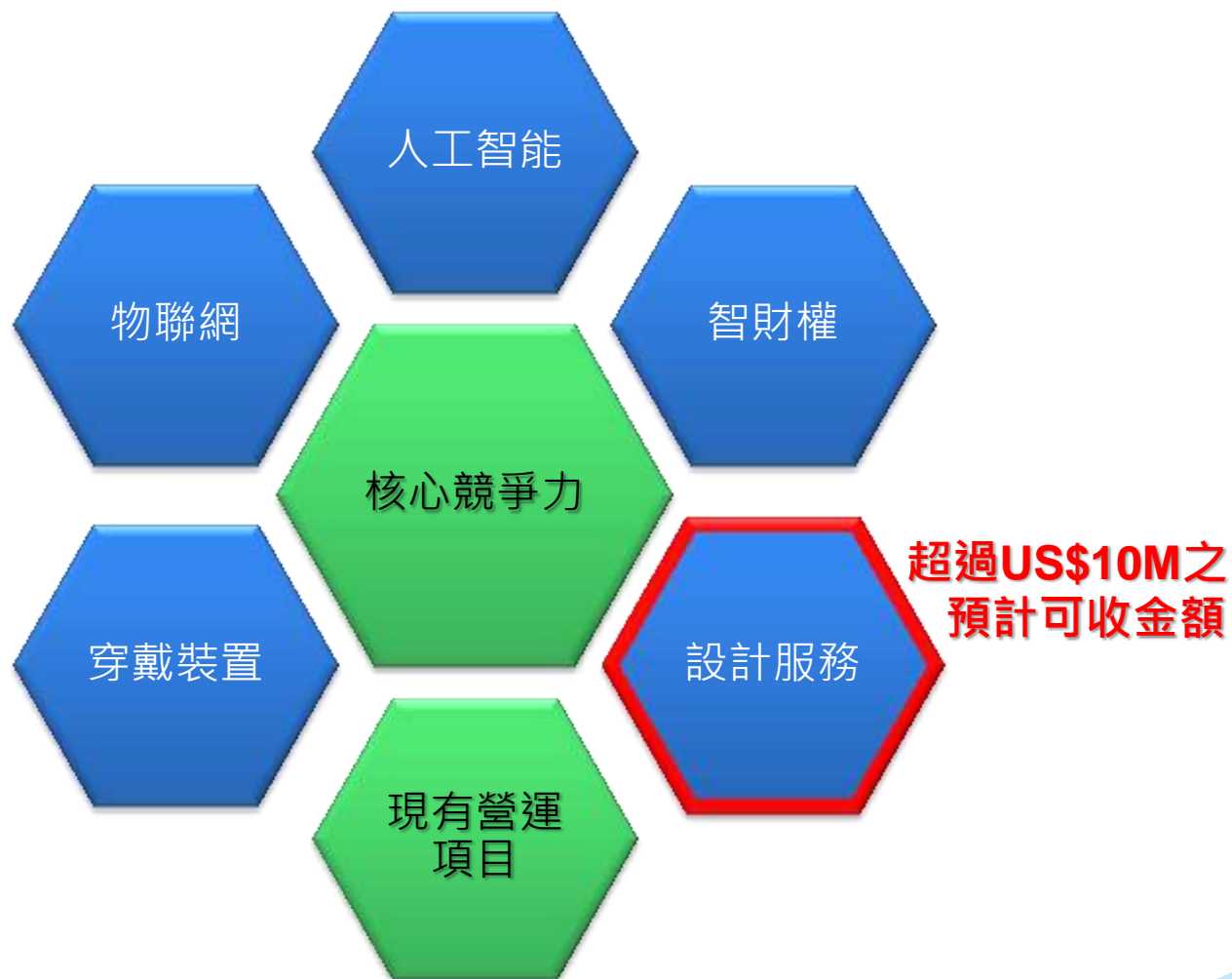

# 設計服務

- 與力晶緊密之夥伴關係
- 其他合作專案
- 已簽約、預計可收服務款項超過美金\$10M
- 營運模式
  - NRE + Royalty or NRE + Product Sale

# 成長動能：IP

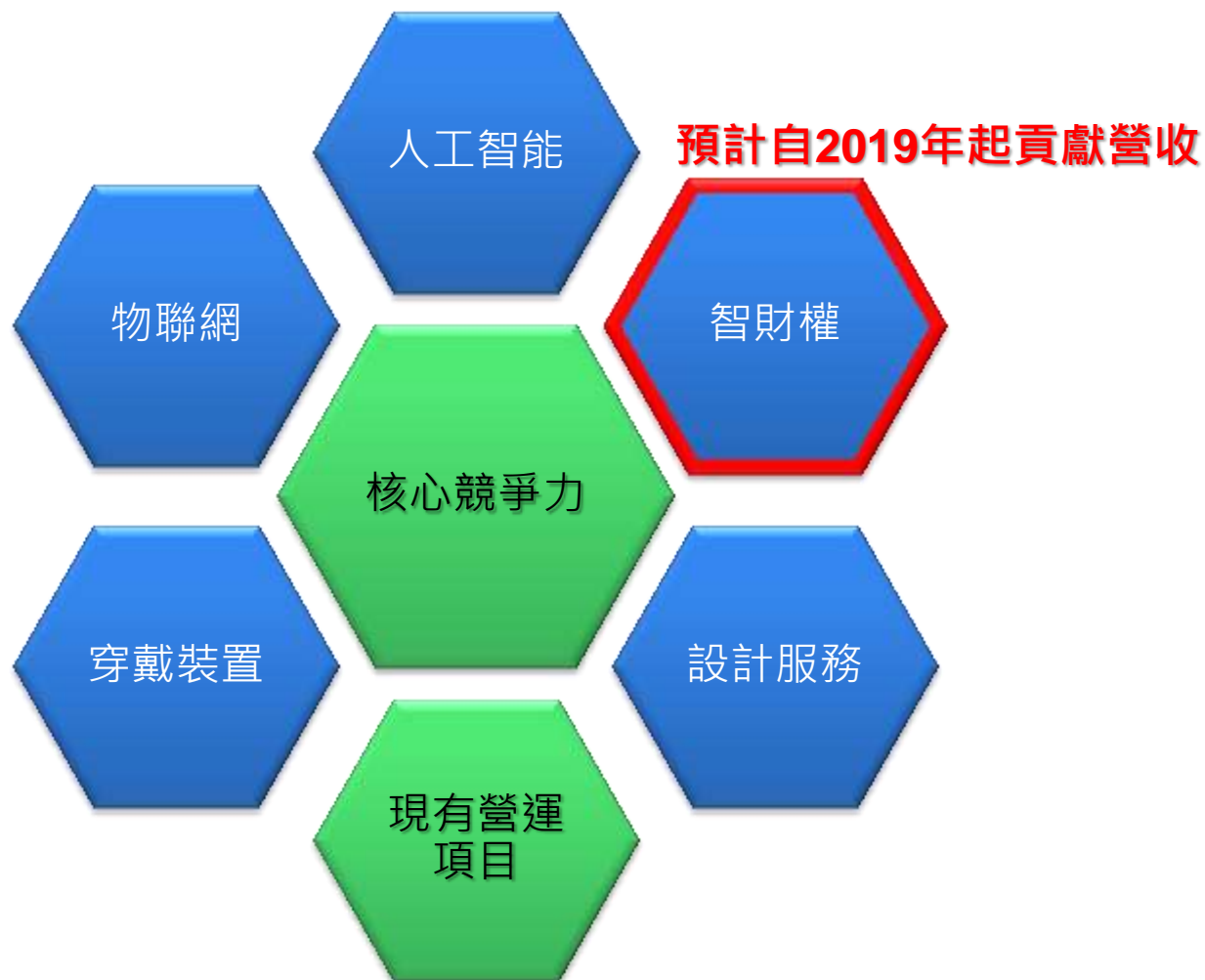

# 進行中的IP

- 2T-SRAM
  - 3X SRAM size reduction for LCD drivers
  - 已簽訂1<sup>st</sup>授權備忘錄
  - 預計自2019年起貢獻營收
- Ferroelectric Memory
  - 研發中
  - 營收貢獻時點未定

# 成長動能：AI

**The future starts now!**



# AI Memory – 可能機會

## 2.5D

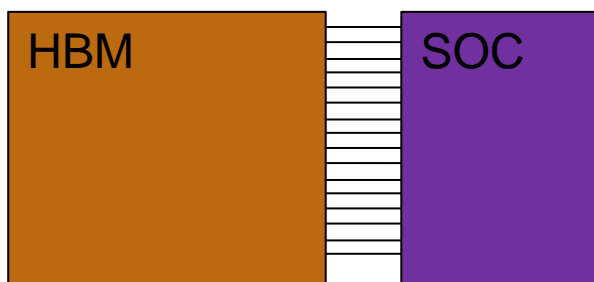
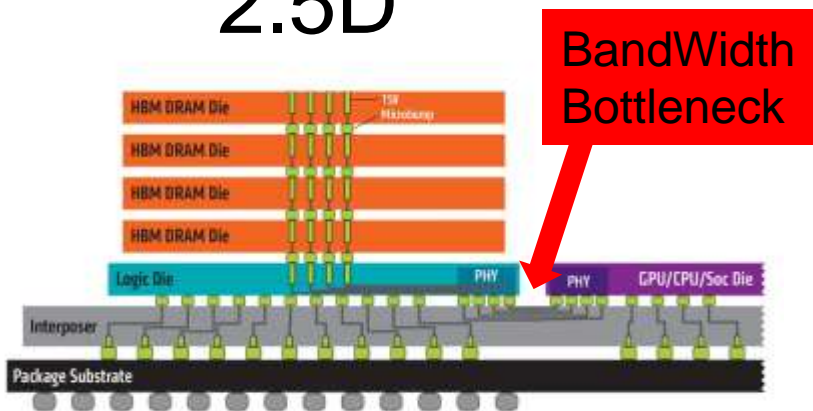

~2,000 connections

## 3D

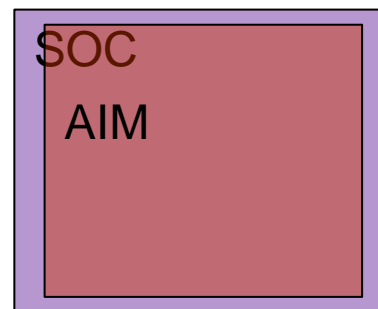
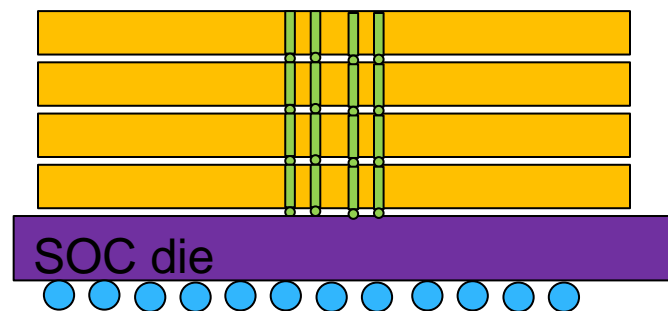

Millions of connections

# 人工智能 / Computing-in-Memory

- AI/CIM Platform: Partnership with Powerchip
  - Enabling Platform with Design Service
  - 3 Contracts signed
  - NRE now, royalty/sales revenue 2019
- 3D stacking
  - Eco-system emerging

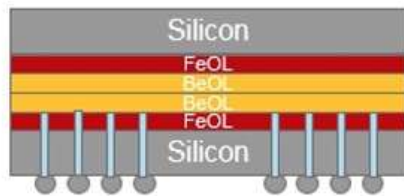

TSMC

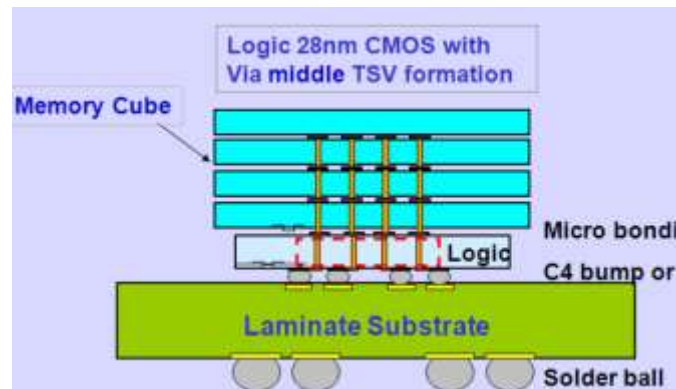

UMC

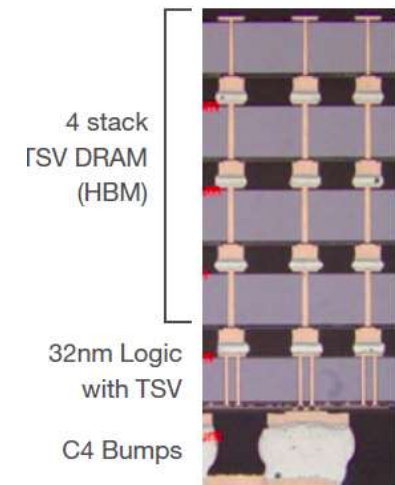

3D Logic + HBM

Global Foundry

# 成長動能：客製化+IP

**The future starts now!**

**~2019年為  
營收貢獻關鍵**

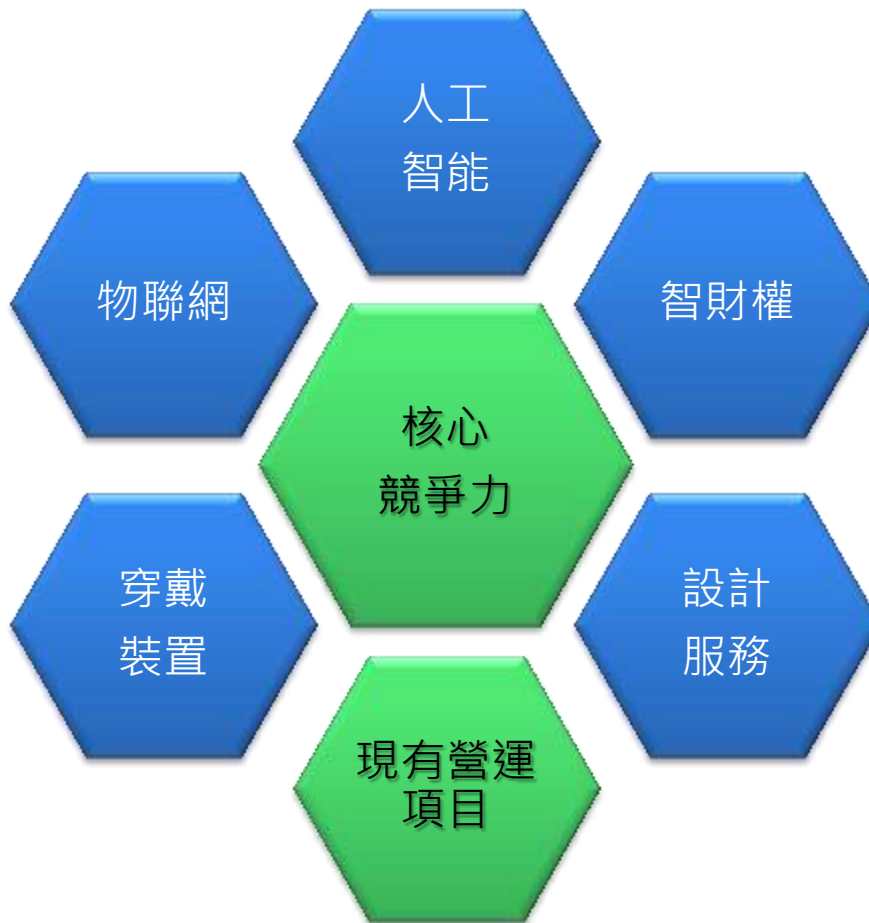

**預計自2019年起  
貢獻營收**

**遍及各平台**

**超過US\$10M之  
預計可收金額**



# 未來成長趨勢

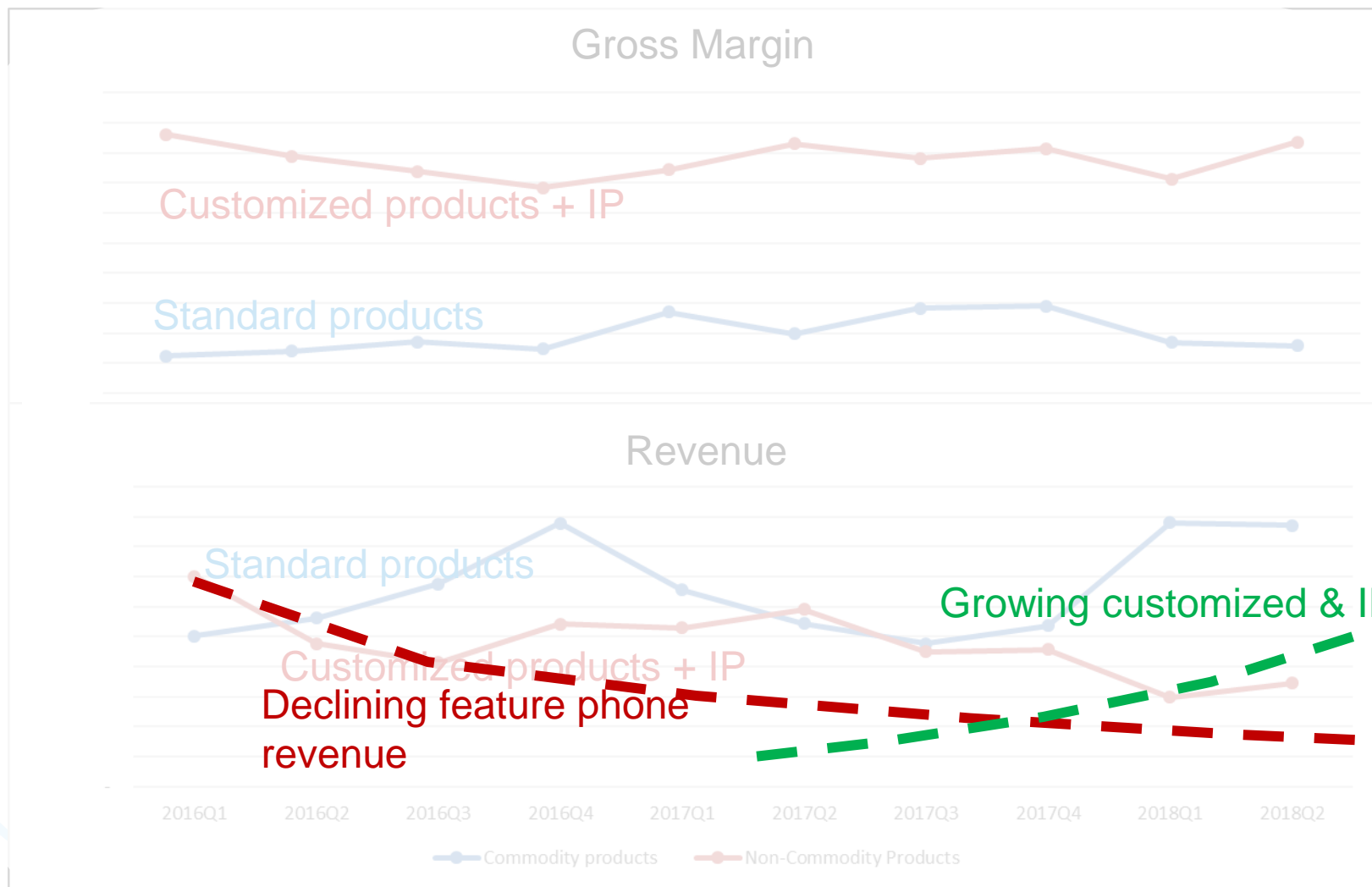

# 2018年上半年度財務重點

# 2018H1 合併損益表

in NT\$K	2018H1	2017H1	YoY	
			ΔAMT	Δ%
營業收入	2,390,789	2,316,803	73,986	3
營業成本	1,938,425	1,757,306	181,119	10
營業毛利	452,364	559,497	( 107,133 )	( 19 )
毛利率 (%)	19%	24%		( 22 )
銷售費用	38,048	64,067	( 26,019 )	( 41 )
管理費用	42,273	55,316	( 13,043 )	( 24 )
研發費用	245,547	177,149	68,398	39
預期信用減損損失	( 597 )	3,987	( 4,584 )	( 115 )
營業費用小計	325,271	300,519	24,752	8
營業淨利	127,093	258,978	( 131,885 )	( 51 )
營業淨利率(%)	5%	11%		( 52 )
業外收支小計	28,264	( 92,208 )	120,472	( 131 )
稅前淨利	155,357	166,770	( 11,413 )	( 7 )
所得稅費用	24,431	58,678	( 34,247 )	( 58 )
本期淨利(損)	130,926	108,092	22,834	21
淨利率(%)	5%	5%		17
歸屬於本公司淨利(損)	130,926	127,091	3,835	3
每股盈餘 (NT\$)	1.85	1.81	0.04	2

# 2018.Q2 合併損益表

in NT\$K	2018.Q2	QoQ			YoY		
		2018.Q1	ΔAMT	Δ%	2017.Q2	ΔAMT	Δ%
Sales revenue	1,215,161	1,175,628	39,533	3	1,132,694	82,467	7
Costs of Goods Sold	989,454	948,971	40,483	4	863,393	126,061	15
Gross Margin	225,707	226,657	( 950 )	( 0 )	269,301	( 43,594 )	( 16 )
Gross Margin Rate (%)	19%	19%	( 4 )	( 4 )	24%	( 22 )	( 22 )
Sales & Mktng Exp.	18,683	19,365	( 682 )	( 4 )	29,507	( 10,824 )	( 37 )
Adm. Exp.	21,215	21,058	157	1	27,459	( 6,244 )	( 23 )
R&D Exp.	127,908	117,639	10,269	9	99,456	28,452	29
Expected Credit Loss	( 975 )	378	( 1,353 )	( 358 )	( 19,686 )	18,711	( 95 )
Operating Expenses	166,831	158,440	8,391	5	136,736	30,095	22
Ope. Income	58,876	68,217	( 9,341 )	( 14 )	132,565	( 73,689 )	( 56 )
Ope. Income Rate (%)	5%	6%	( 17 )	( 17 )	12%	( 59 )	( 59 )
Non-Operating P&L	54,112	( 25,848 )	79,960	( 309 )	12,012	42,100	350
Income before Tax	112,988	42,369	70,619	167	144,577	( 31,589 )	( 22 )
Income Tax Exp.	19,138	5,293	13,845	262	49,651	( 30,513 )	( 61 )
Net Income	93,850	37,076	56,774	153	94,926	( 1,076 )	( 1 )
Net Income Rate (%)	8%	3%	145	145	8%	( 8 )	( 8 )
Net Income for the Company	93,850	37,076	56,774	153	102,589	( 8,739 )	( 9 )
EPS(NT\$)	1.32	0.52	0.80	154	1.46	( 0.14 )	( 10 )

# 2018.06.30 合併資產負債表

in NT\$K	2018.06.30		2017.12.31		ΔAMT	Δ%	2017.06.30		ΔAMT	Δ%
	AMT	%	AMT	%			AMT	%		
現金及約當現金、貨幣基金及3個月以上定存等	869,924	25	1,066,354	33	(196,430)	(18)	1,876,324	38	(1,006,400)	(54)
應收帳款淨額	685,937	20	598,575	18	87,362	15	803,931	28	(117,994)	(15)
存貨淨額	1,315,742	38	942,274	29	373,468	40	672,839	17	642,903	96
其他流動資產	155,906	4	155,596	5	310	0	86,831	4	69,075	80
採用權益法之投資	75,012	2	74,303	2	709	1	71,180	2	3,832	5
不動產、廠房及設備	51,086	2	68,341	2	(17,255)	(25)	126,544	2	(75,458)	(60)
商譽	76,204	2	76,204	3	-	-	76,204	2	-	-
其他無形資產	97,708	3	102,502	3	(4,794)	(5)	107,807	3	(10,099)	(9)
其他非流動資產	157,075	4	159,604	5	(2,529)	(2)	151,047	2	6,028	4
資產總計	3,484,594	100	3,243,753	100			3,972,707	100		
長、短期借款	150,000	4	100,000	3	50,000	50	160,000	7	(10,000)	(6)
應付帳款	473,892	14	385,981	12	87,911	23	606,217	11	(132,325)	(22)
其他應付款(註)	171,164	5	101,840	3	69,324	68	241,747	4	(70,583)	(29)
本期所得稅負債	16,346	-	47,649	2	(31,303)	(66)	68,050	1	(51,704)	(76)
其他	27,344	1	10,941	-	16,403	150	7,172	1	20,172	281
負債總計	838,746	24	646,411	20			1,083,186	25		
普通股股本	748,095	22	709,293	22	38,802	5	706,453	18	41,642	6
資本公積總計	845,944	24	826,272	25	19,672	2	808,499	21	37,445	5
保留盈餘	1,074,412	31	1,085,893	34	(11,481)	(1)	1,057,237	28	17,175	2
其他	(22,603)	(1)	(24,116)	(1)	1,513	(6)	(23,353)	(1)	750	(3)
本公司業主權益	2,645,848	76	2,597,342	80			2,548,836	66		
非控制權益	-	-	-	-	-	-	340,685	9	(340,685)	(100)
權益總計	2,645,848	76	2,597,342	80			2,889,521	75		
每股淨值	35.37		36.62				36.08			

註：其他應付款主係應付股利、應付員工/董事酬勞、應付光罩及探針卡、應付未休假給付、應付薪資及獎金等。

# 2018上半年度現金流量情形

in NT\$K	合併	
	2018Q2	2017Q2
營業活動之現金流量		
營運產生之現金	( 243,419 )	548,976
收取之利息	4,267	3,143
支付之利息	( 535 )	( 1,960 )
支付之所得稅	( 47,994 )	( 55,654 )
營業活動之淨現金流入(出)	( 287,681 )	494,505
投資活動之現金流量		
投資活動之淨現金流入(出)	36,824	( 39,695 )
籌資活動之現金流量		
籌資活動之淨現金流入(出)	53,595	( 117,356 )
匯率變動對現金及約當現金之影響	2,132	( 1,956 )
現金及約當現金淨(減少)增加	( 195,130 )	335,498
期初現金及約當現金餘額	1,061,883	1,376,210
期末現金及約當現金餘額	866,753	1,711,708

# 2018 年上半年度財務結構

	2018.H1	2017
流動比率	362.13%	427.29%
速動比率	190.55%	267.63%
平均收現天數*	50天	74天
存貨周轉天數*	117天	108天
純益率	5.48%	5.58%
資產報酬率*	7.81%	6.73%

\* 調整為年化基礎

# 結論

- 短期目標
  - 提升獲利能力
  - 專注高毛利產品
  - 低功耗記憶體 銷售→授權
- 中期目標
  - 優化核心業務
  - 執行開發計畫





## Q & A

發言人信箱：[ir@apmemory.com](mailto:ir@apmemory.com)

發言人專線：(03)5601651

Line：

